

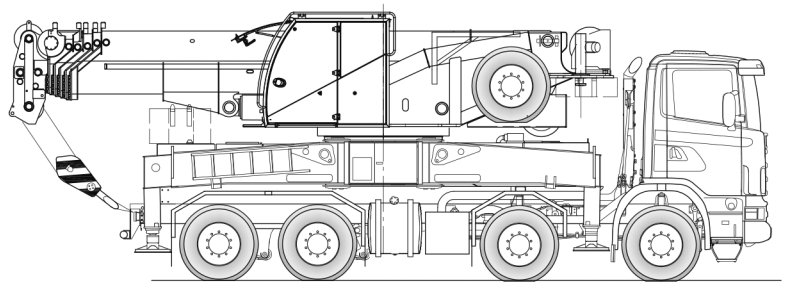

MARCHETTI
autogru spa



MTK 1005 II

AUTOGRU SU CAMION "LIBERA CIRCOLAZIONE"

TRUCK MOUNTED CRANE



Dimensioni (mm)
Dimensions (mm)

MTK 1005 II

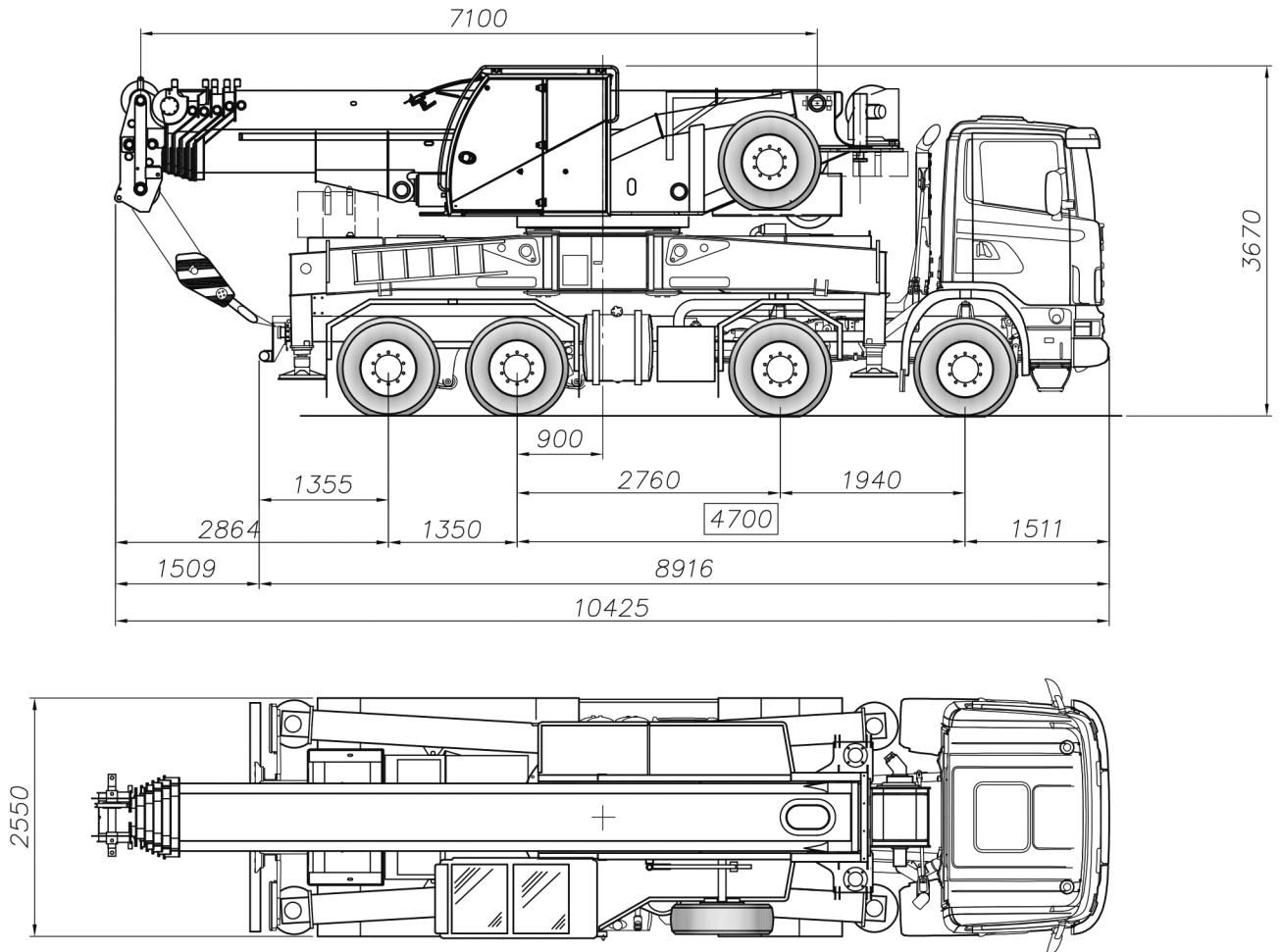

Dimensioni indicative, variabili in funzione dell'autotelaio.

Il disegno mostra applicazione su autotelaio Scania G 450 CB 8x4 HHA Euro 6

Dimensions may change depending on the truck.

This drawing shows the crane MTK1005 II installed on Scania G 450 CB 8x4 HHA Euro 6

Pesi Weights





MTK 1005 II

	Contrappesi - Counterweight 	1° + 2°	3° + 4°	Massa totale - GVW
(t)	-	13,5	18,5	32 (*)
(t)	8,4	16	26	42 (**)

Le masse possono variare in funzione dell'autotelaio. (*) equipaggiamento di base; (**) incluso zavorre ed accessori.
Weights may change depending on the truck. (*) standard equipment; (**) including counterweight and options.

Prestazioni della gru Performances



Meccanismo - Drive	Infinitamente variabile - Infinitely variable	Ø / L	Sforzo max sulla fune - Max single line pull
	0 - 100 m/min	18 mm / 165 m	53 kN
	0 - 110 m/min	16 mm / 125 m	49 kN
	0 - 1.5 min ⁻¹ (Approx.)		
	7,1 m - 31,5 m : 120 s (Approx.)		
	0° - 80° : 60 s (Approx.)		

Bozzelli Hook blocks



Tipo - Type	Carrucole - Sheaves	Tagli - Lines	Peso - Weight (Kg)
50t	5	10	580
40t	4	8	450
32t	3	6	350
16t	1	3	290
8t	-	1	110

Descrizione Technical description

MTK 1005 II



SOVRASTRUTTURA

Portata massima 100 ton @ 2 m , installabile su autotelaio commerciale 4 assi 8x4

TELAIO E STABILIZZATORI

Telaio in acciaio ad alta resistenza di tipo radiale. N.4 travi con sfilo telescopico e con apertura a bandiera. Movimenti indipendenti per ogni azionamento. Comandi dalla cabina gru e da entrambi i lati del carro. Sistema anticollisione con il camion. Tabelle di portata con stabilizzazione parziale. Piastre degli stabilizzatori d.500 mm sempre agganciate. Controllo posizione e carico sugli stabilizzatori.

TRASLAZIONE

Comandi sterzo, freni e traslazione in cabina di manovra per spostamenti a bassa velocità in cantiere.

IMPIANTO IDRAULICO

Azionato dalla presa di forza, di tipo "load sensing" con una pompa a cilindrata variabile a pistoni assiali e regolazione di potenza, per l'azionamento della gru. Due pompe ad ingranaggi per l'azionamento della rotazione, stabilizzatori, zavorra, servizi. Possibilità di azionamento di 4 manovre contemporanee. Due leve di comando a 4 posizioni. Serbatoio olio 800 l. Raffreddamento dell'olio idraulico.

IMPIANTO ELETTRICO

Sistema canbus. Impianto elettrico 24 Vdc. N.3 fari di lavoro

ROTAZIONE

Riduttore epicicloidale con freno automatico a molla. Motore a pistoni e valvola di frenatura. Ralla a due giri di sfere, dentatura interna.

ARGANO

Riduttore epicicloidale con freno automatico a molla. Motore a pistoni. Tamburo scanalato. Fune antigirevole, parallela, compattata.

SOLLEVAMENTO BRACCIO

N.1 cilindro idraulico diff. con valvola di controllo discesa pilotata.

BRACCIO

Telescopico in acciaio ad alta resistenza a 6 sezioni: 1 elemento di base, 2 elementi a sfilo indipendente, 3 elementi a sfilo sincronizzato. Sfilamento sotto carico parziale. Lunghezza: 7,1m – 31,5 m. Testa inclinabile 0°-30°-60° per lavoro in interni.

BOZZELLO

Bozzello a 5 carrucole, tipo 50 t

ZAVORRA

In 2 pezzi; massa totale 8,4 t; componibile e automontante comandata dalla cabina.

CABINA

Cabina ergonomica ad alta visibilità. Pedana estraibile. Impianto di riscaldamento. Vetro superiore di sicurezza. Vetro anteriore apribile. Controlli e comandi completi. Monitor 7" per visualizzazione delle pagine: lavoro, motore, settaggi, diagnostica. Inclinaz. idraulica 0-20°.

DISPOSITIVI DI SICUREZZA

Valvole di massima pressione su tutte le funzioni idrauliche. Valvole di blocco e di controllo sui cilindri e motori idraulici. Limitatore di momento. Fine corsa in salita e discesa del bozzello. Indicatore di carico a 3 luci (semaforo). Cicalino. Lampeggiante. Estintore.

RUMORE

Conforme alla Direttiva 2000/14/CE (emendata da 2005/88/CE).

VERNICIATURA

Poliuretano bicomponente: grigio RAL 7016 e giallo RAL 50% 1006 + 50% 1007. Altri colori a richiesta.

MARCATURA CE

Conforme alla direttiva 2006/42/CE.

ACCESSORI A RICHIESTA

Prolunga tralicciata in due pezzi, lunghezza 6,9m – 12m, ripiegabile a lato del braccio, inclinazione : 0°-20°-40°.
Argano ausiliario. Argano di traino.
Falcone da 1,3 m a 30°. Gancio fisso 22 t.
Limitatore area di lavoro. Radiocomando.
Servizio di assistenza remota con telemetria e GPS (per industria 4.0).
Zavorra speciale in 3 pezzi, totale 11 t.
Bozzelli di varie portate. Aria condizionata nella cabina in torre.

SUPERSTRUCTURE

Maximum capacity 100 ton @ 2m, to be installed on commercial truck chassis, 4 axles 8x4

OUTRIGGERS

Radial type crane chassis fixed onto the truck chassis. 4 hydraulic-controlled telescoping beam outriggers and vertical jacks with independent movements; controls located on each side of the carrier and in the upper structure cab. Anti-collision system with the truck for safe and easy operation. Partial stabilization is also possible. Outrigger plate d. 500 mm, always engaged. Outrigger position control and outrigger load display.

TRAVEL

Steering, brakes and forward+rear travel from the crane cab for slow speed motions on site.

HYDRAULIC SYSTEM

Driven by PTO, load sensing hydraulic system with 1 x piston pump for crane's operation and 2 x gear pump for service circuits. Possibility of activating 4 contemporary manoeuvres. N.2 proportional dual axis joystick for crane control. Oil tank 800 l. Oil heat exchanger.

ELECTRIC SYSTEM

Canbus data system. 24 Vdc. N.3 working lights.

SLEWING

Continuous 360° slewing achieved by epicyclic reducer with automatic multiple discs brake in oil bath. Heavy duty slew ring with double ball rim and internal geared ring.

HOIST GEAR

Grooved drum. Hydraulic piston motor, epicyclic reducer and automatic multiple disk brake in oil bath. Non rotating rope, langs lay, compacted strands.

LUFFING GEAR

Differential hydraulic cylinder equipped with piloted load control valve.

BOOM

6-section telescopic boom, length ranging from 7,1 m to 31,5 m, full hydraulic extension (1 x base section, 2 x independent telescopic section, 3 x synchronized telescopic sections). Tilttable boom head 0°-30°-60°

HOOK BLOCK

Type 50 ton hook block, 5 sheaves, ram horn type.

COUNTERWEIGHT

8,4 ton modular counterweight installed with hydraulic cylinders controlled from the crane cab.

CAB

Excellent visibility cab with safety roof glass. Gasoil heating. Comprehensive instrumentation and controls for the crane. 7" colour display showing working, engine, setting and diagnostic pages. Hydraulically tilttable 0-20°.

SAFETY DEVICES

Lifting hoist limit switch, safety and pressure valves, emergency stop device and electronic moment limiter device. 3-color warning signal light positioned on the front. Buzzer. Rotating light. Fire extinguisher.

NOISE EMISSIONS

According to 2000/14/EC (amended by 2005/88/EC), annex VI

PAINTING

Polyurethane bi-component paint: grey RAL 7016 and yellow RAL 50% 1006 – 50% 1007 or in the colour specified by the customer.

CE MARKING

The crane is compliant with the 2006/42/EC directive and is provided with CE marking and Operation & Maintenance Manual.

ADDITIONAL EQUIPMENT AND ACCESSORIES

Lattice boom extension, twofold 6,9m - 12m, offset 0°, 20°, 40°, foldable alongside main boom during travel.
Auxiliary winch. Towing winch.
Jib 1.3 m 30°. Fixed hook 22 t.
Working area limiter. Radio remote control.
Remote connection service with telemetry and GPS.
Special counterweights, 3 pieces, total 11 t.
Various hook blocks. Air conditioning in crane cab.

Altezze di sollevamento
Maximum tip height

MTK 1005 II



7,1 – 31,5 m



7,1x6,4m



270°+90°



8,4 t

DIN ISO









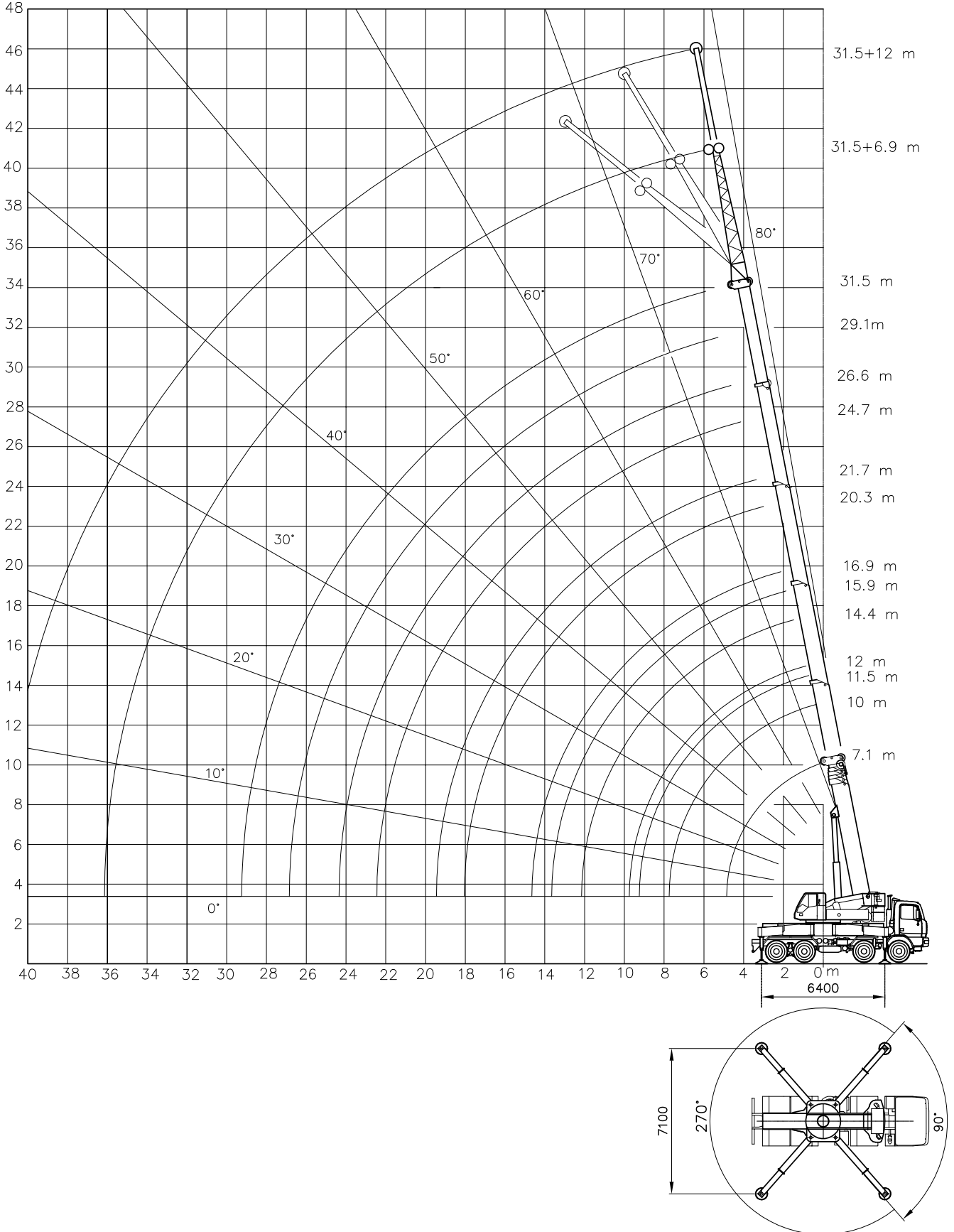

Tabella di portata del braccio
Lifting capacities on main boom

MTK 1005 II

 7,1-31,5 m		 7,1x6,4m					 270°		 11 t			DIN ISO		
 m	7,1	10,0	11,5	12,0	14,4	15,9	16,9	20,3	21,7	24,7	26,6	29,1	31,5	 m
 m	t	t	t	t	t	t	t	t	t	t	t	t	t	 m
2	100,0													2
2,5	80,0													2,5
3	68,9	56,0	50,0	43,2	38,9	32,8								3
3,5	62,6	56,0	48,9	40,3	38,9	32,8	25,4							3,5
4	57,4	55,8	46,0	37,0	38,9	32,8	24,6	22,0						4
5		48,6	41,0	31,6	37,5	32,0	22,4	22,0	22,0	22,0				5
6		42,6	34,6	27,5	32,8	28,8	20,2	22,0	22,0	22,0	14,2	15,5	12,0	6
7		34,9	30,9	24,2	29,0	25,5	18,2	22,0	20,9	21,5	13,3	15,5	11,3	7
8			26,1	21,6	26,1	22,8	16,3	21,0	19,2	19,7	12,4	15,1	10,5	8
9			23,0	19,4	20,8	20,5	14,7	19,8	17,6	18,0	11,4	14,3	9,8	9
10					18,8	17,0	13,4	18,1	16,1	16,4	10,5	13,2	9,0	10
11					16,8	14,2	12,2	15,5	14,8	15,2	9,6	12,2	8,3	11
12					14,5	12,1	11,3	13,3	13,2	13,8	9,0	11,3	7,8	12
13						11,1	10,5	11,6	11,5	12,1	8,2	10,5	7,1	13
14							10,0	10,2	10,1	10,7	7,7	9,9	6,7	14
15								9,0	8,9	9,5	7,1	9,3	6,2	15
16								8,0	7,9	8,5	6,6	8,6	5,9	16
17								7,1	7,0	7,6	6,1	7,7	5,5	17
18								6,3	6,3	6,8	5,8	7,0	5,2	18
19									5,6	6,3	5,4	6,3	4,9	19
20										6,0	5,0	5,7	4,6	20
22										5,2	4,4	4,8	4,1	22
24											3,6	4,2	3,7	24
26												3,5	3,4	26
28													2,8	28

















 7,1-31,5 m		 7,1x6,4m					 90°		 11 t			DIN ISO		
 m	7,1	10,0	11,5	12,0	14,4	15,9	16,9	20,3	21,7	24,7	26,6	29,1	31,5	 m
 m	t	t	t	t	t	t	t	t	t	t	t	t	t	 m
2,5	80,0													2,5
3	68,9	56,0	50,0	43,2	38,9	32,8								3
3,5	62,6	56,0	48,9	40,3	38,9	32,8	25,4							3,5
4	57,4	55,8	46,0	37,0	38,9	32,8	24,6	22,0						4
5		48,6	41,0	31,6	37,5	32,0	22,4	22,0	22,0	22,0				5
6		39,6	34,6	27,5	32,8	28,8	20,2	22,0	22,0	22,0	14,2	15,5	12,0	6
7		28,3	27,2	24,2	26,2	25,3	18,2	22,0	20,9	21,5	13,3	15,5	11,3	7
8			23,3	20,5	22,3	20,5	16,3	20,5	19,2	19,7	12,4	15,1	10,5	8
9			18,7	16,1	19,3	16,4	14,7	17,3	16,8	16,9	11,4	14,3	9,8	9
10					16,0	13,7	13,3	14,7	14,4	14,6	10,5	13,2	9,0	10
11					13,5	12,7	12,1	12,3	12,2	12,8	9,6	12,2	8,3	11
12					11,6	11,8	11,3	10,5	10,4	11,0	9,0	10,9	7,8	12
13						10,3	10,4	9,0	8,9	9,5	8,2	9,6	7,1	13
14							9,2	8,3	7,7	8,6	7,7	8,4	6,7	14
15								7,8	6,8	8,0	7,1	7,4	6,2	15
16								7,4	5,9	7,2	6,3	6,6	5,9	16
17								6,8	5,2	6,4	5,6	6,0	5,5	17
18								6,1	4,6	5,8	4,9	5,5	5,2	18
19									4,0	5,2	4,4	4,9	4,7	19
20										4,8	3,9	4,4	4,3	20
22										3,9	3,4	3,6	3,5	22
24											3,0	3,0	2,8	24
26												2,4	2,3	26
28													1,8	28

Tabella di portata del braccio
Lifting capacities on main boom

MTK 1005 II

 7,1-31,5 m		 7,1x6,4m		 270°		 8,4 t		DIN ISO						
 m	7,1	10,0	11,5	12,0	14,4	15,9	16,9	20,3	21,7	24,7	26,6	29,1	31,5	 m
 m	t	t	t	t	t	t	t	t	t	t	t	t	t	 m
2	100,0													2
2,5	80,0													2,5
3	68,9	56,0	50,0	43,2	38,9	32,8								3
3,5	62,6	56,0	48,9	40,3	38,9	32,8	25,4							3,5
4	57,4	55,8	46,0	37,0	38,9	32,8	24,6	22,0						4
5		48,6	41,0	31,6	37,5	32,0	22,4	22,0	22,0	22,0				5
6		42,6	34,6	27,5	32,8	28,8	20,2	22,0	22,0	22,0	14,2	15,5	12,0	6
7		31,7	30,6	24,2	29,0	25,5	18,2	22,0	20,9	21,5	13,3	15,5	11,3	7
8			26,1	21,6	23,6	22,8	16,3	21,0	19,2	19,7	12,4	15,1	10,5	8
9			20,9	18,3	20,5	18,6	14,7	19,4	17,6	18,0	11,4	14,3	9,8	9
10					17,9	15,2	13,4	16,6	16,1	16,4	10,5	13,2	9,0	10
11					15,2	12,7	12,2	14,0	13,8	14,4	9,6	12,2	8,3	11
12					13,1	11,9	11,3	11,9	11,8	12,4	9,0	11,3	7,8	12
13						11,1	10,5	10,3	10,2	10,8	8,2	10,5	7,1	13
14							10,0	9,0	8,9	9,5	7,7	9,6	6,7	14
15								7,9	7,8	8,4	7,1	8,5	6,2	15
16								7,4	6,9	7,5	6,6	7,6	5,9	16
17								6,9	6,1	7,1	6,1	6,8	5,5	17
18								6,2	5,4	6,7	5,8	6,1	5,2	18
19									4,8	6,0	5,2	5,5	4,9	19
20										5,5	4,7	5,1	4,6	20
22										4,6	3,8	4,3	4,1	22
24											3,0	3,6	3,4	24
26												3,0	2,8	26
28													2,3	28

















 7,1-31,5 m		 7,1x6,4m		 90°		 8,4 t		DIN ISO						
 m	7,1	10,0	11,5	12,0	14,4	15,9	16,9	20,3	21,7	24,7	26,6	29,1	31,5	 m
 m	t	t	t	t	t	t	t	t	t	t	t	t	t	 m
2,5	80,0													2,5
3	68,9	56,0	50,0	43,2	38,9	32,8								3
3,5	62,6	56,0	48,9	40,3	38,9	32,8	25,4							3,5
4	56,9	55,8	46,0	37,0	38,9	32,8	24,6	22,0						4
5		48,3	41,0	31,6	37,5	32,0	22,4	22,0	22,0	22,0				5
6		35,2	32,1	27,5	29,9	28,8	20,2	22,0	22,0	22,0	14,2	15,5	12,0	6
7		25,1	26,1	23,9	24,7	22,3	18,2	22,0	20,9	21,2	13,3	15,5	11,3	7
8			20,8	17,9	21,3	17,9	16,3	18,1	17,6	17,6	12,4	15,1	10,5	8
9			16,6	15,0	17,1	14,9	14,3	15,2	14,7	14,9	11,4	14,2	9,8	9
10					14,2	13,7	13,0	12,9	12,6	12,8	10,5	12,3	9,0	10
11					12,0	12,2	12,1	10,8	10,6	11,2	9,6	10,8	8,3	11
12					10,2	10,4	10,5	9,5	9,0	9,9	9,0	9,5	7,8	12
13						9,1	9,2	8,9	7,7	9,0	8,0	8,4	7,1	13
14							8,0	8,3	6,6	7,9	7,0	7,3	6,7	14
15								7,4	5,7	7,0	6,1	6,6	6,2	15
16								6,6	5,0	6,2	5,3	5,9	5,7	16
17								5,9	4,4	5,5	4,7	5,2	5,0	17
18								5,3	4,2	5,0	4,3	4,6	4,5	18
19									4,0	4,5	4,0	4,1	4,0	19
20										4,0	3,8	3,7	3,5	20
22										3,3	3,3	3,0	2,8	22
24											2,7	2,4	2,2	24
26												1,9	1,7	26
28													1,3	28

Tabella di portata del braccio
Lifting capacities on main boom

MTK 1005 II

 7,1-31,5 m		 7,1x6,4m					 270°			 0 t			DIN ISO	
 m	7,1	10,0	11,5	12,0	14,4	15,9	16,9	20,3	21,7	24,7	26,6	29,1	31,5	 m
 m	t	t	t	t	t	t	t	t	t	t	t	t	t	 m
2,5	80,0													2,5
3	68,9	56,0	50,0	43,2	38,9	32,8								3
3,5	62,6	56,0	48,9	40,3	38,9	32,8	25,4							3,5
4	56,9	55,8	46,0	37,0	38,9	32,8	24,6	22,0						4
5		42,4	38,3	31,6	35,1	32,0	22,4	22,0	22,0	22,0				5
6		29,9	28,4	26,5	26,0	24,2	20,2	22,0	22,0	22,0	14,2	15,5	12,0	6
7		20,9	22,9	19,7	22,8	18,6	18,2	18,7	18,0	18,0	13,3	15,5	11,3	7
8			17,4	15,7	18,0	16,3	15,5	15,2	14,7	14,8	12,4	14,1	10,5	8
9			13,8	12,2	14,4	14,5	14,2	12,7	12,3	12,6	11,4	11,9	9,8	9
10					11,8	12,0	12,1	11,0	10,3	11,5	10,1	10,2	9,0	10
11					9,9	10,1	10,2	10,3	8,6	10,0	8,6	8,8	8,3	11
12					8,4	8,6	8,7	8,9	7,1	8,5	7,5	7,9	7,5	12
13						7,4	7,5	7,7	6,0	7,3	6,3	6,9	6,6	13
14							6,5	6,8	5,5	6,3	5,7	6,0	5,8	14
15								5,9	5,1	5,5	5,3	5,2	5,0	15
16								5,2	4,8	4,9	4,9	4,5	4,3	16
17								4,7	4,4	4,3	4,3	3,9	3,7	17
18								4,1	4,2	3,8	3,8	3,4	3,3	18
19									3,8	3,3	3,4	3,0	2,8	19
20										3,0	3,0	2,6	2,5	20
22										2,3	2,4	2,0	1,8	22
24											1,8	1,5	1,3	24
26												1,1	0,9	26
28													0,6	28

























 7,1-31,5 m		 7,1x6,4m					 90°			 0 t			DIN ISO	
 m	7,1	10,0	11,5	12,0	14,4	15,9	16,9	20,3	21,7	24,7	26,6	29,1	31,5	 m
 m	t	t	t	t	t	t	t	t	t	t	t	t	t	 m
2,5	80,0													2,5
3	68,9	56,0	50,0	43,2	38,9	32,8								3
3,5	62,6	56,0	48,9	40,3	38,9	32,8	25,4							3,5
4	56,9	48,9	44,4	37,0	38,9	32,8	24,6	22,0						4
5		30,3	28,5	26,2	26,0	23,3	22,4	22,0	21,6	21,1				5
6		21,0	22,3	19,6	21,2	19,9	19,1	16,7	16,0	15,9	14,2	14,8	12,0	6
7		14,6	16,6	14,6	16,4	16,1	15,9	13,7	12,4	13,6	11,8	11,8	11,3	7
8			12,4	10,7	13,0	13,1	12,9	12,5	9,9	11,1	9,6	10,0	9,4	8
9			9,7	8,1	10,2	10,4	10,5	10,5	8,1	9,3	8,6	8,4	7,8	9
10					8,3	8,5	8,6	8,8	7,3	8,0	7,8	7,1	6,6	10
11					6,9	7,0	7,1	7,4	6,7	6,8	6,7	6,1	5,7	11
12					5,7	5,9	6,0	6,2	6,3	5,8	5,8	5,2	4,9	12
13						5,0	5,1	5,3	5,4	4,9	5,0	4,5	4,2	13
14							4,4	4,6	4,7	4,2	4,2	3,8	3,6	14
15								4,0	4,1	3,6	3,6	3,2	3,1	15
16								3,5	3,5	3,1	3,1	2,7	2,6	16
17								3,0	3,1	2,7	2,7	2,3	2,1	17
18								2,6	2,7	2,3	2,3	1,9	1,8	18
19									2,4	1,9	2,0	1,6	1,5	19
20										1,7	1,7	1,3	1,2	20
22										1,2	1,2	0,9	0,7	22
24											0,8	0,5	0,3	24
26														26
28														28

Tabella di portata – stab. parziale
Lifting capacities – partial outrigger base

MTK 1005 II

 7,1-31,5 m		 4,75 x 4,2 m						 270°			 8,4 t			DIN ISO	
 m	7,1	10,0	11,5	12,0	14,4	15,9	16,9	20,3	21,7	24,7	26,6	29,1	31,5	 m	
 m	t	t	t	t	t	t	t	t	t	t	t	t	t	 m	
2,5	58,4													2,5	
3	54,8	54,3	50,0	43,2	38,9	32,8								3	
3,5	49,0	48,5	48,3	40,3	38,9	32,8	25,4							3,5	
4	44,2	42,9	39,5	37,0	36,4	32,8	24,6	22,0						4	
5		30,7	29,4	27,8	26,5	25,6	22,4	22,0	22,0	22,0				5	
6		22,6	24,3	21,8	23,5	19,9	19,4	19,7	19,1	18,9	14,2	15,5	12,0	6	
7		17,1	18,7	17,1	19,1	17,9	17,1	16,1	15,6	15,7	13,3	14,9	11,3	7	
8			14,9	13,5	15,4	15,5	15,5	13,5	13,0	13,7	12,4	12,6	10,5	8	
9			12,3	10,9	12,7	12,9	13,0	11,9	11,0	12,1	10,7	10,8	9,8	9	
10					10,7	10,9	11,0	11,0	9,4	10,5	9,3	9,4	9,0	10	
11					9,1	9,3	9,4	9,6	7,9	9,2	8,1	8,5	8,1	11	
12					7,8	8,0	8,1	8,3	6,7	7,9	7,0	7,5	7,1	12	
13						7,0	7,1	7,3	5,9	6,9	6,1	6,6	6,3	13	
14							6,2	6,4	5,5	6,1	5,7	5,7	5,5	14	
15								5,7	5,1	5,4	5,3	5,0	4,8	15	
16								5,1	4,8	4,7	4,8	4,4	4,2	16	
17								4,6	4,4	4,2	4,3	3,9	3,7	17	
18								4,1	4,2	3,8	3,8	3,5	3,3	18	
19									3,8	3,4	3,4	3,1	2,9	19	
20										3,0	3,0	2,7	2,5	20	
22										2,4	2,4	2,1	1,9	22	
24											1,9	1,6	1,5	24	
26												1,2	1,0	26	
28													0,7	28	

 7,1-31,5 m		 4,75 x 4,2 m						 90°			 8,4 t			DIN ISO	
 m	7,1	10,0	11,5	12,0	14,4	15,9	16,9	20,3	21,7	24,7	26,6	29,1	31,5	 m	
 m	t	t	t	t	t	t	t	t	t	t	t	t	t	 m	
2,5	58,4													2,5	
3	54,8	49,8	45,9	43,2	38,9	32,8								3	
3,5	45,6	39,2	36,9	34,7	32,3	30,6	25,4							3,5	
4	36,2	31,6	29,9	28,4	26,4	25,2	24,4	22,0						4	
5		22,3	23,3	21,0	22,2	21,7	21,3	18,0	17,3	17,1				5	
6		16,4	18,0	15,9	17,3	17,0	16,8	14,8	13,6	14,5	12,9	12,9	12,0	6	
7		12,1	13,7	12,2	14,1	13,9	13,8	13,3	11,0	12,0	10,6	10,9	10,3	7	
8			10,8	9,4	11,3	11,5	11,5	11,2	9,0	10,1	9,4	9,1	8,6	8	
9			8,8	7,4	9,2	9,4	9,5	9,6	7,9	8,6	8,5	7,8	7,4	9	
10					7,7	7,8	7,9	8,1	7,3	7,5	7,4	6,7	6,3	10	
11					6,5	6,6	6,7	6,9	6,7	6,5	6,4	5,8	5,5	11	
12					5,5	5,7	5,8	6,0	6,0	5,6	5,6	5,1	4,8	12	
13						4,9	5,0	5,2	5,3	4,8	4,8	4,5	4,2	13	
14							4,3	4,5	4,6	4,2	4,2	3,8	3,6	14	
15								4,0	4,0	3,6	3,7	3,3	3,1	15	
16								3,5	3,6	3,1	3,2	2,8	2,7	16	
17								3,1	3,2	2,7	2,8	2,4	2,3	17	
18								2,7	2,8	2,4	2,4	2,1	1,9	18	
19									2,5	2,1	2,1	1,8	1,6	19	
20										1,8	1,8	1,5	1,3	20	
22										1,3	1,4	1,0	0,9	22	
24											0,9	0,6	0,5	24	
26														26	
28														28	

Sfilo sotto carico
Telescopic extens. capacities

MTK 1005 II

 7,1-15,9 m

 7,1x6,4m

 270°

 8,4 t

DIN ISO



Tabella di portata della prolunga tralicciata e del jib
Lifting capacities on the folding jib and 1,3m jib

MTK 1005 II



31,5 m

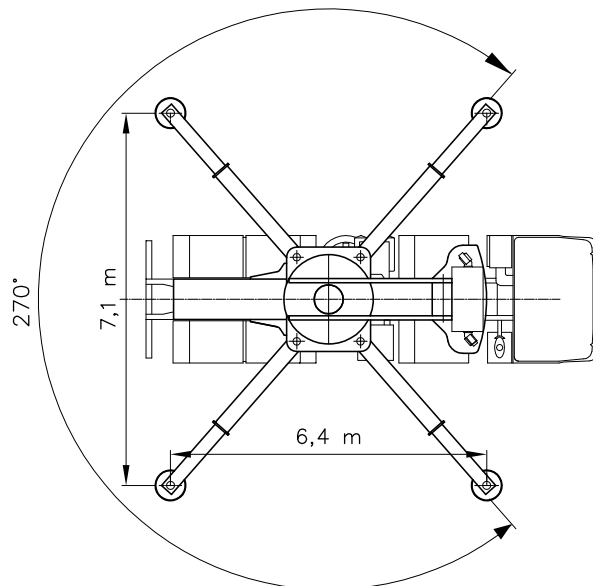
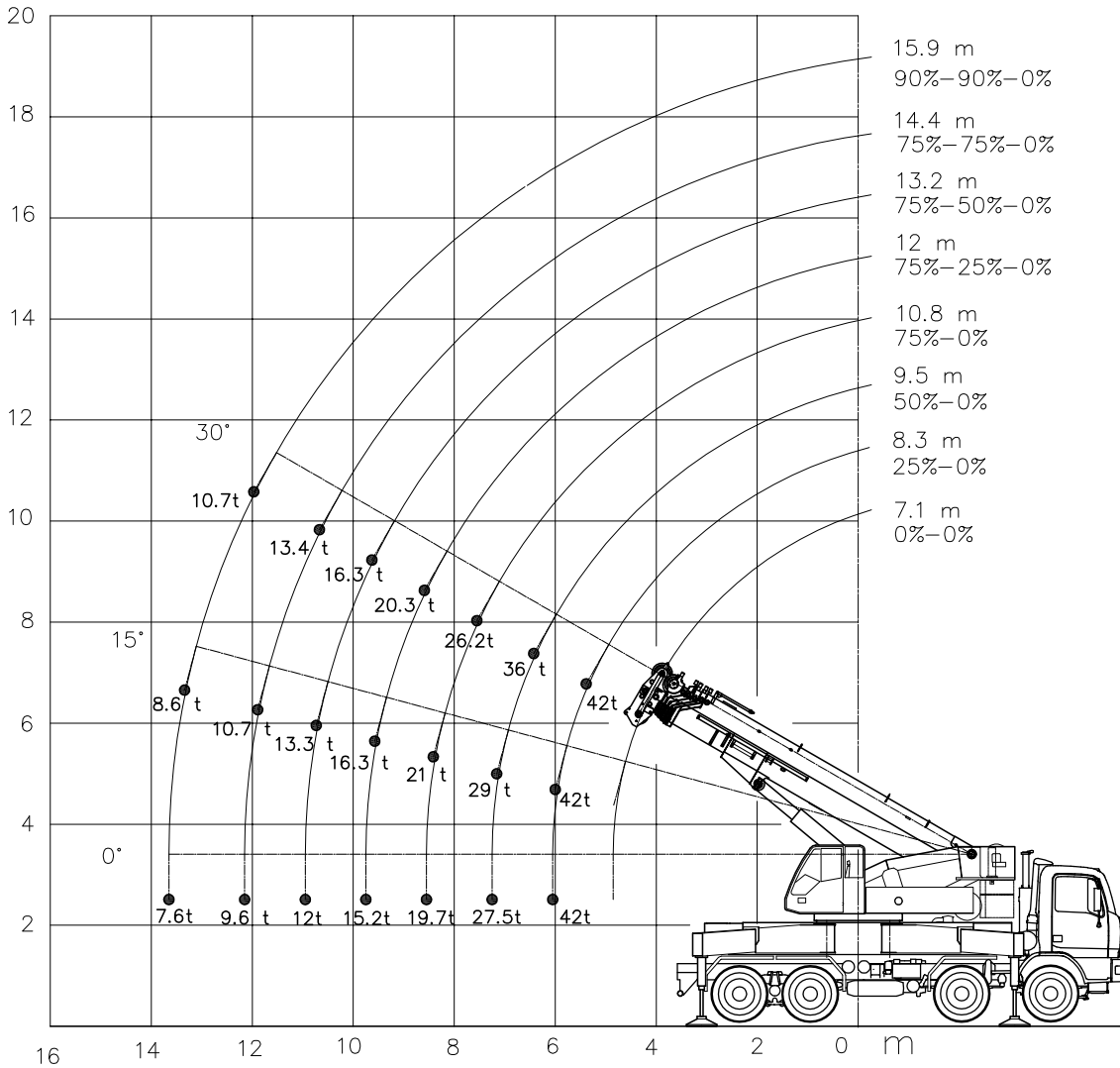
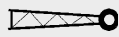

6,9 m



7,1x6,4 m



270°

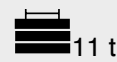

11 t

DIN-ISO

	6,9 m			12,0 m			
	0°	20°	40°	0°	20°	40°	
	t	t	t	t	t	t	
6,0	5,7						6,0
8,0	5,3	3,7		3,1			8,0
10,0	5,0	3,5	2,8	2,8			10,0
12,0	4,6	3,3	2,7	2,7	1,8		12,0
14,0	4,3	3,1	2,6	2,6	1,7	1,4	14,0
16,0	3,9	3,0	2,5	2,4	1,6	1,3	16,0
18,0	3,5	2,9	2,5	2,2	1,5	1,2	18,0
20,0	3,2	2,8	2,4	2,0	1,5	1,2	20,0
22,0	2,9	2,6	2,4	1,8	1,4	1,2	22,0
24,0	2,6	2,4	2,3	1,7	1,4	1,1	24,0
26,0	2,4	2,2	2,2	1,6	1,3	1,1	26,0
28,0	2,1	2,1	2,1	1,5	1,3	1,1	28,0
30,0	1,9	1,9		1,4	1,2	1,1	30,0
32,0	1,7	1,7		1,3	1,2	1,0	32,0
34,0	1,5	1,5		1,2	1,1	1,0	34,0
36,0	1,3			1,1	1,1		36,0
38,0				1,0	1,1		38,0
40,0				0,9			40,0



1,3 m 30°



7,1x6,4 m



270°



11 t

DIN-ISO

	24,7 m	29,1 m	31,5 m	
	t	t	t	
4,0				4,0
6,0	9,5	8,5		6,0
8,0	9,5	8,5	7,0	8,0
10,0	9,5	8,3	7,0	10,0
12,0	9,3	8,0	6,8	12,0
14,0	9,0	7,5	6,2	14,0
16,0	8,4	6,8	5,5	16,0
18,0	6,8	6,1	4,8	18,0
20,0	5,5	5,6	4,3	20,0
22,0	1,0	4,7	3,8	22,0
24,0		3,9	3,5	24,0
26,0			3,1	26,0
28,0				28,0



Via Caorsana 49
29122 Piacenza - Italy
Tel. ++39.0523.573711
Fax ++39.0523.593253
Web: www.marchetti.it
E-mail: mark@marchetti.it

Per il costante miglioramento del prodotto, dati e caratteristiche tecniche possono variare a nostro giudizio senza alcun obbligo di preavviso. Le informazioni riportate sono solo a titolo indicativo. La messa in servizio della macchina richiede l'osservanza del manuale d'uso e delle tabelle di portata fornite con la macchina.

In accordance with our policy of constant improvement, we reserve the right to amend this specification at any time without notice. Data published in this brochure is to be intended as a guide; crane operation is subject to the observance of the Use & Maintenance manual and the Lifting Charts supplied with the machine.

Suivant notre politique d'amélioration, nous nous réservons le droit de modifier sans préavis certaines des caractéristiques indiquées dans cette notice. Les renseignements ci-inclus, sont données à titre d'exemple; la mise en service de la machine est autorisée à condition que le manuel d'utilisation et d'entretien et les tableaux de charges fournies soient observés.

Zur ständigen Verbesserung des Produktes können wir jederzeit beschließen, Angaben und technische Eigenschaften ohne Vorankündigung zu ändern. Die hier wiedergegebenen Informationen dienen nur zum Hinweis. Die Inbetriebsetzung der Maschine erfordert die Beachtung der Gebrauchsanweisung und der mitgelieferten Tragfähigkeitstabellen.

MTK 1005 II

Note relative alle tabelle di carico Remarks referring to load charts

- I carichi indicati rispettano la norma EN13000.
- La gru può lavorare con velocità del vento corrispondente a 5 e 7 Beaufort, in funzione della lunghezza del braccio.
- I pesi dei ganci e di tutti gli accessori per l'imbragatura fanno parte del carico e devono essere dedotti dai carichi indicati.
- I carichi indicati per il braccio principale sono intesi con prolunga tralicciata e falcone smontati.
- I carichi sono indicati in tonnellate.
- I raggi di lavoro sono calcolati a partire dall'asse di rotazione della torretta.
- Le portate indicate sono intese con stabilizzatori sfilati alla massima estensione.
- Carichi superiori a 56,2 t eseguibili solamente con equipaggiamento supplementare.
- The lifting capacities are based on EN13000.
- Crane operation is permissible up to wind corresponding to 5 and 7 Beaufort depending on boom length.
- Working radii are measured from the slewing centreline.
- Weight of hook blocks and slings is part of the load, and must be deducted from the capacity ratings.
- The lifting capacities given for the telescopic boom only apply if the folding jib and jib are dismounted.
- Lifting capacities are given in metric tons.
- The lifting capacities shown are with fully extended outriggers.
- Lifting capacities above 56,2 t only with special equipment.